

K-no.: 27092 K-Nr.:	Core design: Toroidal core Ausführung: Ringbandkern	Date: 11.11.2019 Datum:
	Application: Common Mode Choke Anwendung: Stromkompensierte Drossel	
Customer: Standard Type / Typenelement Kunde	Customer part no.: Kd. Sach Nr.:	Page 1 of 6 Seite von

Drawing / Maßbild
 Without scale / ohne Maßstab

Dimensions of the boxed core in mm /
 Maße des getroigten Kerns in mm

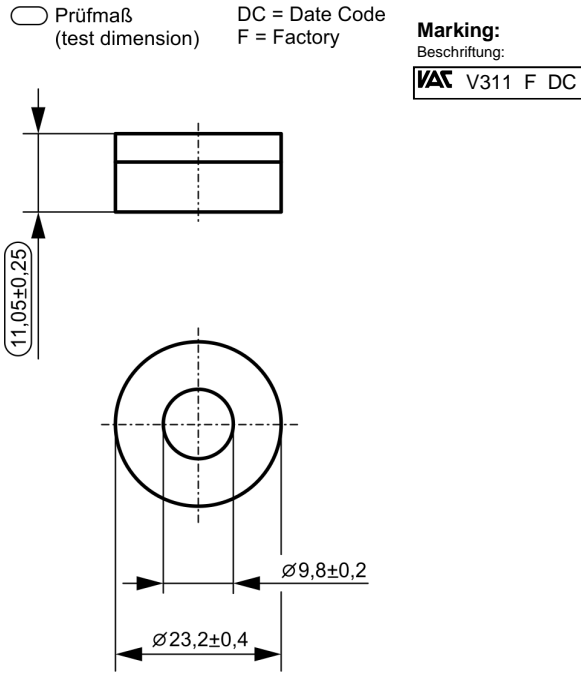

Date	Name	Issue	Amendment
		01	
Hrsg.: R&D-PD NPI D editor		Bearb.: NB designer	MC-PM: FTr. check
			freig.: Pr. released

K-no.: 27092 K-Nr.:	Core design: Toroidal core Ausführung: Ringbandkern	Date: 11.11.2019 Datum:
	Application: Common Mode Choke Anwendung: Stromkompensierte Drossel	
Customer: Standard Type / Typenelement Kunde	Customer part no.: Kd. Sach Nr.:	Page 2 of 6 Seite von

 Core material / Legierung:
VITROPERM 500 F

 Type of finish / Fixierung:
Fix 022

 Core fixing / Kernfixierung:
silicone rubber / Silikonkautschuk

 Material of casing / Trogmateriale:
PA10T/X, GF30

SYMBOL	PARAMETER	VALUE / WERT	UNIT / EINHEIT
A_{Fe}	Effective area / Effektiver Eisen-Querschnitt	0,25	cm ²
l_{Fe}	Effective length / Effektive Länge	5,1	cm
m_{Fe}	Mass of bare core / blankes Kerngewicht	~ 9	g
m	Mass of fixing core / Gewicht des eingetrogten Kerns	~ 11g	g
A_{L0} (10 kHz)	Nominal magnetic values / Magn. Nennwerte	19,9	μH
A_{L0} (100 kHz)	Nominal magnetic values / Magn. Nennwerte	10,5	μH
A_L (10 kHz, 100kHz)	Magnetic tolerance range / Magn. Toleranzbereich	-25 +45	%
T_{op}	Operating temperature / Betriebstemperatur	- 40 bis +150	°C
T_{st}	Storage temperature / Lagertemperatur	- 40 bis +85	°C

Inspection / Prüfung: (V: 100%-Test; AQL...: DIN ISO 2859-Part1, SC = significant characteristic)

Nr.	Parameter to test / Prüfparameter	Test method / Prüfmethode	Reference
	Mechanical test		
1)	1.1) $n = 5, c = 0 / lot / n = 5, C = 0 / Los$ All test dimensions according to drawing page 1 / alle Prüfmaße gemäß Maßbild Seite 1	Sample inspection	Test instrument: vernier calliper Prüfmittel: Prüfllehre
	1.2) Max. height acc to drawing page 1 / max Höhe gemäß Maßbild Seite 1	V	Test instrument: gauge / Prüfmittel: Prüfllehre
3)	Magnetical test / magnetische Prüfung		
	3.1) Setting values / Einstellwerte $I_{eff} \times N = 10,8 \text{ mA}^{**}, f = 10 \text{ kHz}$ $14,93 \mu\text{H} < A_L (10 \text{ kHz}) < 28,86 \mu\text{H} \text{ SC}$ **(corr. / entspr $H_{peak}=3\text{mA/cm}$)	V	Test of A_L -value in series mode according to A60092-Y3022- K009 / Prüfung des A_L -Wertes im Reihenersatzschaltbild gemäß A60092-Y3022-K009
3.2) Setting values / Einstellwerte $I_{eff} \times N = 10,8 \text{ mA}^{**}, f = 100 \text{ kHz}$ $7,88\mu\text{H} < A_L (100 \text{ kHz}) < 15,23\mu\text{H}$ **(corr. / entspr $H_{peak}=3\text{mA/cm}$)			

 Measurements after temperature balance of the test samples at room temperature
Messungen nach Temperaturangleich der Prüflinge an Raumtemperatur

Hrsg.: R&D-PD NPI D editor	Bearb: NB designer	MC-PM: FTr. check			freig.: Pr. released
-------------------------------	-----------------------	----------------------	--	--	-------------------------

K-no.: 27092
K-Nr.:

Core design: Toroidal core
Ausführung: Ringbandkern
Application: Common Mode Choke
Anwendung: Stromkompensierte Drossel

Date: 11.11.2019
Datum:

Customer: Standard Type / Typenelement
Kunde

Customer part no.:
Kd. Sach Nr.:

Page 3 of 6
Seite von

Typical characteristics / Typische Kurven:

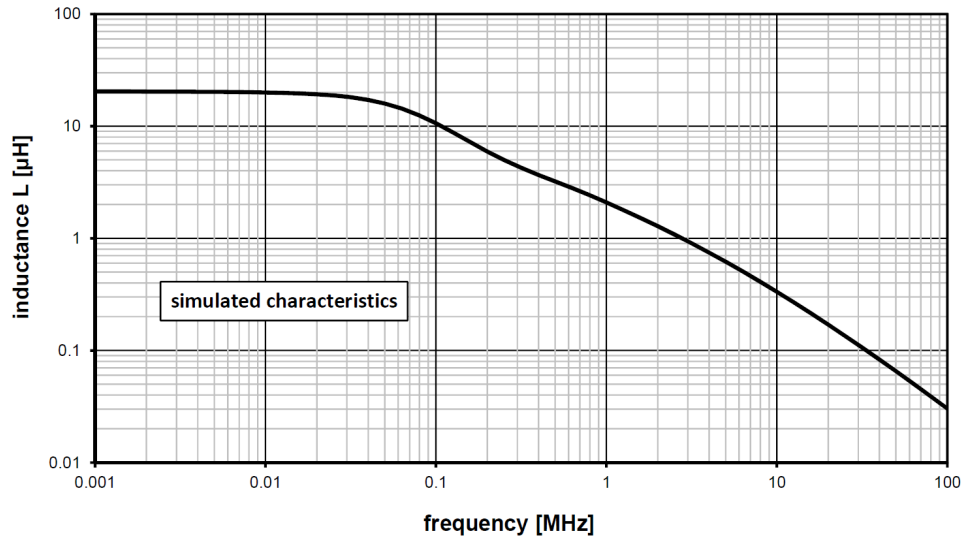
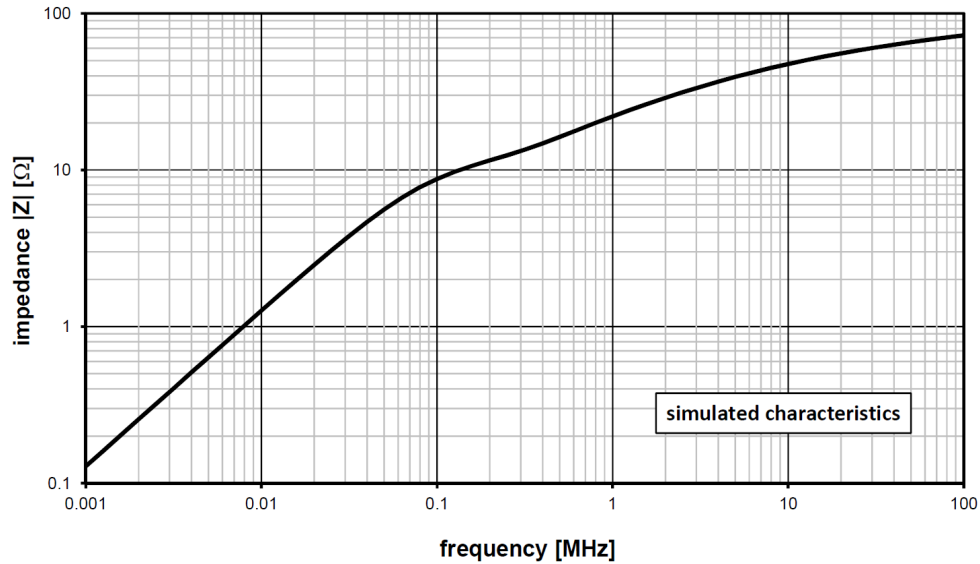

Hrsg.: R&D-PD NPI D
editor

Bearb: NB
designer

MC-PM: FTr.
check

freig.: Pr.
released

K-no.: 27092 K-Nr.:	Core design: Toroidal core Ausführung: Ringbandkern	Date: 11.11.2019 Datum:
	Application: Common Mode Choke Anwendung: Stromkompensierte Drossel	
Customer: Standard Type / Typenelement Kunde	Customer part no.: Kd. Sach Nr.:	Page 4 of 6 Seite von

Technical cleanliness / Technische Sauberkeit

VAC carries out regularly extraction analysis with similar cores. The similarity refers to the size and the manufacturing process of the component. The extraction analysis is based on the guideline on ZVEI and VDA-Band 19. On basis on this data material, VAC can submit following proposal as preliminary. The final establishing will be done after minimum 5 analysis of serial product in serial production site / Die VAC führt regelmäßig Extraktionsanalysen an ähnlich Kernen durch. Die Ähnlichkeit bezieht sich auf die Größe und die Herstellverfahren. Diese Extraktionsanalysen werden auf Basis des ZVEI-Leitfadens und des VDA-Band 19 durchgeführt. Auf Basis dieses Datenmaterials kann die VAC folgenden Vorschlag als vorläufige Festlegung abgeben. Die finale Festlegung erfolgt nach mind. 5 Analysen von Produkten aus der Serienfertigung vom Serienstandort.

Current action control limits are shown in Table 1:

Aktuelle Eingriffsgrenzen in Tabellenform

Particle size x [µm]: Statistical maximum particle amount per 1000 cm² component surface area before shipment / Partikelgröße [µm]: Statistisch maximale Partikelmenge pro 1000 cm² Bauelementoberfläche vor Auslieferung

Particle size [µm]	Size class	Overall ¹	Metallic
x < 25	B-C	not evaluated	not evaluated
25 ≤ x < 50	D	19439	1860
50 ≤ x < 100	E	5130	720
100 ≤ x < 150	F	821	112
150 ≤ x < 200	G	202	29
200 ≤ x < 400	H	194	8
400 ≤ x < 600	I	21	1
600 ≤ x < 1000	J	8	1
>1000	K	3	0

Table 1: proposal of VAC towards technical cleanliness (reference surface : 1000 cm²)

Decay Curve ²	A019953
Surface area per core	18,4 cm ²
Number of cores per analysis	12
Pre-spray quantity ²	500 ml
Waiting time between pre-spray a. cleaning	60 s
Spray quantity for cleaning ²	4.2 l
Rewash quantity for basin ²	200 ml

Table 1: Parameter cleanliness analysis

¹: Overall: Metallic and non-metallic, non-fibrous particles.
Fibre definition: Compactness <30% or length/width > 10

²: example values, the exact values will be added later on

Hrsg.: R&D-PD NPI D editor	Bearb: NB designer		MC-PM: FTr. check		freig.: Pr. released
-------------------------------	-----------------------	--	----------------------	--	-------------------------

K-no.: 27092 K-Nr.:	Core design: Toroidal core Ausführung: Ringbandkern	Date: 11.11.2019 Datum:
	Application: Common Mode Choke Anwendung: Stromkompensierte Drossel	
Customer: Standard Type / Typenelement Kunde	Customer part no.: Kd. Sach Nr.:	Page 5 of 6 Seite von

2. Packaging, drawings, quantities and weight / Skizzen, Mengen und Gewichte

A) Tray / Formling

Drawing / Skizze

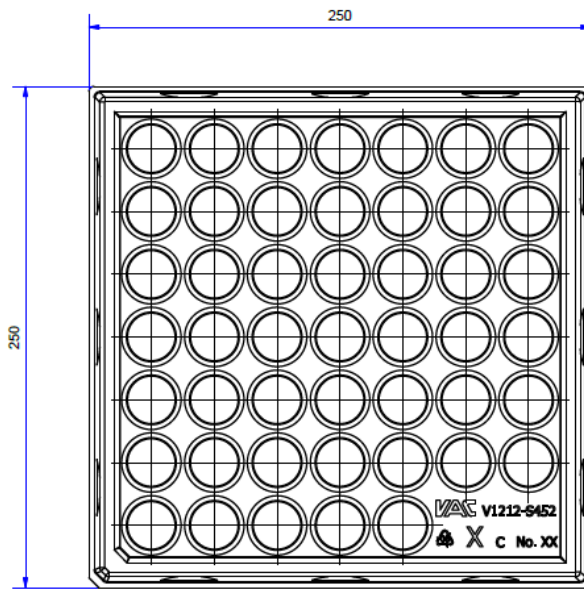

Formling stapelbar
(tray stackable)

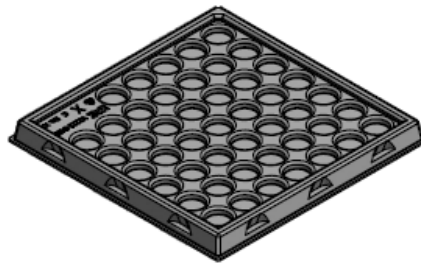
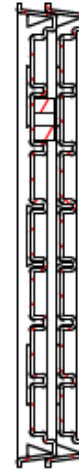

Hrsg.: R&D-PD NPI D editor	Bearb: NB designer	MC-PM: FTr. check	freig.: Pr. released
-------------------------------	-----------------------	----------------------	-------------------------

K-no.: 27092 K-Nr.:	Core design: Toroidal core Ausführung: Ringbandkern	Date: 11.11.2019 Datum:
	Application: Common Mode Choke Anwendung: Stromkompensierte Drossel	
Customer: Standard Type / Typenelement Kunde	Customer part no.: Kd. Sach Nr.:	Page 6 of 6 Seite von

B) Outer packaging / Umverpackung

Drawing / Skizze

carton for type V311

Der verbleibende freie Raum oberhalb der Trays muss komplett mit Karton-Lagen aufgefüllt sein.
Die Trays müssen sicher fixiert sein und dürfen keine Möglichkeit zur Bewegung haben, wenn der Umkarton geschlossen ist.

The remaining free space on the top of the trays must be completely filled up with layers.
The trays must fit save without any possibility of movement when the outer carton box is closed.

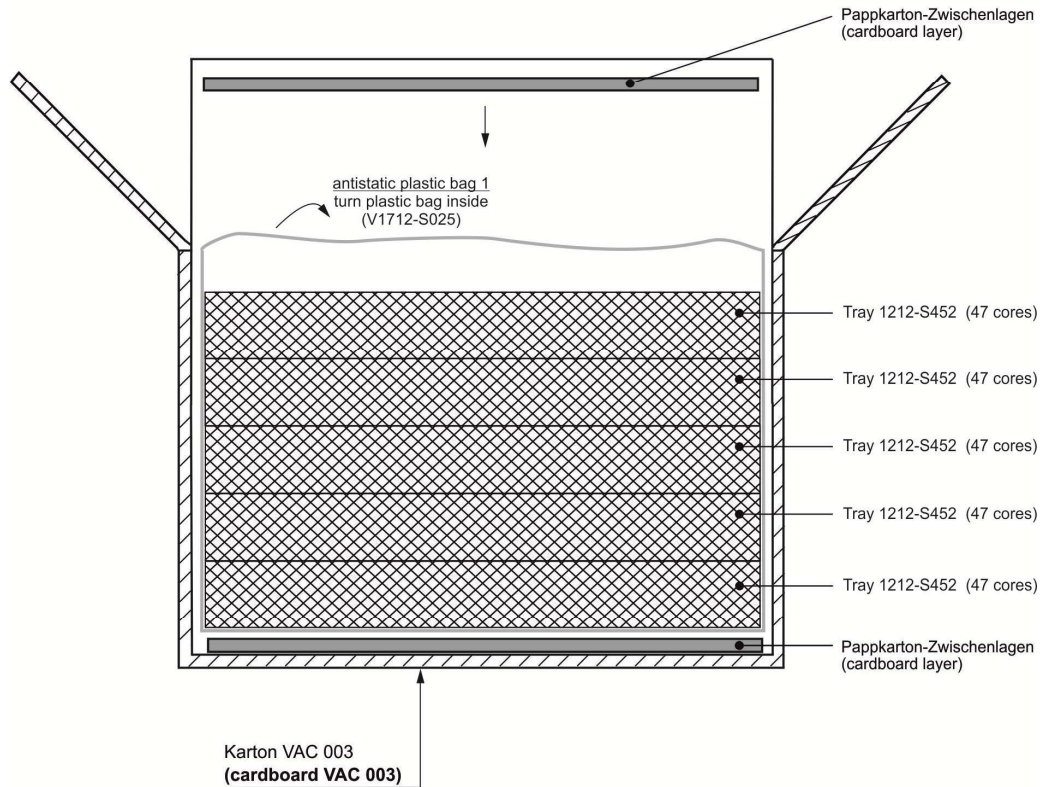

235 Stück Kerne in einem Karton
235 pcs cores in the cardboard

Weight carton loaded: 4,2 kg / Gesamtgewicht Karton befüllt

Outer dimensions carton: 257 x 257 x 97 mm / Außenmaße Karton

Mat.-Nr: 96881550

Hrsg.: R&D-PD NPI D editor	Bearb.: NB designer	MC-PM: FTr. check	freig.: Pr. released
-------------------------------	------------------------	----------------------	-------------------------